



Sunpitch

Sunselect



O perating Instructions & Product Care Manual



Retractable Fabric Awnings

"Our Name Reflects Our Quality"

THANK YOU!

Congratulations on your decision to purchase a Perfecta retractable awning. We are committed to providing you with a quality awning that gives you shade on demand quickly and conveniently. To insure a long life for your awning, we ask that you please refer to the instructions listed within this manual. If you have further questions concerning the care, maintenance, or operation of your Perfecta awning, please contact your local Perfecta dealer.

Your awning has been constructed by our exceptional team at Perfecta Awnings, Inc. located in Coopersburg, Pennsylvania. We are a family-based business which strives for perfection in each and every unit we build. Thank you again for choosing our Company; you are now part of our family.



Retractable Fabric Awnings

"Our Name Reflects Our Quality"

www.perfectaawnings.com

Table of Contents

1.0 Introduction

1.1 Symbols used in this manual

2.0 Safety

2.1 General Safety Information

2.2 Safety Devices

2.3 Residual Risks

3.0 Description of Awning

3.1 Components

3.2 Conditions for Use

3.3 Label

4.0 Transport & Installation

4.1 Transport

4.2 Installation

5.0 Use

5.1 Manual Awning

5.2 Motorized Operation

5.3 Automatic Operation

6.0 Maintenance

6.1 Routine Maintenance

6.2 Routine Cleaning

6.3 Troubleshooting

6.4 Extraordinary Maintenance

7.0 Dismounting & Disposal

Introduction

1.0

- This manual is an integral part of the **Sunpitch and Sunselect** awning models and has been written for users. It is of fundamental importance for using and maintaining the product properly. It is forbidden to remove, rewrite or in any way modify the pages and contents of this manual.
- The manual must be kept in one piece and stored in an easily accessible location until the awning is disposed.
- If the manual is lost or destroyed, please ask your dealer for a new copy, specifying the main product data and where the new copy should be sent.
- The manufacturer reserves the right to update the product and relative manuals without being required to update existing products and manuals.
- The manufacturer reserves all rights to this manual; it may not be fully or partly reproduced without written permission.
- If the product is tampered with or modified without the manufacturer's permission, the latter hereby declines all liability for any damage that may derive.

SYMBOLS USED IN THIS MANUAL

1.1

Please note the **WARNING SYMBOLS** used in this manual as shown below.



INFORMATION AND PRECAUTIONS

Instructions and useful advice for using and preserving. Failure to act on these messages may impair the integrity and/or resistance of the product.



ATTENTION

OPERATOR HAZARD! These instructions and indications should be closely assessed and observed. Failure to act on these messages may be hazardous for people.

Safety

2.0

GENERAL SAFETY INFORMATION

2.1

- In the event of rain, wind or snow, fully close the awning. Failure to do so could cause danger of personal injury or damage to property.
- It is strictly forbidden to remove the safety devices installed on the awning (*see Chapter 2.2 "Safety Devices"*).
- Powered awnings are opened and closed with a switch and/or a remote control unit; both of these devices must be kept **OUT OF REACH OF CHILDREN**.
- Make sure no-one is standing near the awning while it is opening/closing.
- Do not place objects on the awning fabric.
- It is forbidden to hang from or hold onto the awning. Failure to do so could cause risk of serious personal injury and damage to the awning.
- In case of doubt, consult your dealer **BEFORE** using the awning.
- Users may not perform unauthorized operations on the awning (*see Chapter 3.2 "Conditions of use" and Chapter 6 "Maintenance"*).
- If the product is tampered with or modified without the manufacturer's permission, the latter hereby declines all liability for any damage that may derive.
- The user must promptly inform the dealer if faults and/or malfunctions are found on a safety device, or if any hazardous situations arise.

- All maintenance and cleaning operations must be performed with the main power supply disconnected.
- Installation, initial start-up, adjustment and extraordinary maintenance operations may only be performed by a qualified authorized Perfecta Dealer. This insures that in the event of a justified claim, competent experts will support you with advice and service, and warranty claims can be honored. Know that your local Perfecta dealer will be glad to provide assistance to remedy any situation.

SAFETY DEVICES

2.2

EMERGENCY: In the event of a power outage, the awning can be closed with an emergency crank as long as the motor was purchased with an override function. If you have a hardwired wall switch, the switch **MUST** be in the neutral/middle position in order to use the emergency crank.

POWER FAILURE: Power failures will render your awning inoperable. Damages caused by motion or power failures are not covered under warranty.

(OPTIONAL, only for powered awnings)

MOTION SENSOR: In case of strong winds, the awning closes automatically. The retraction level of the motion sensor is adjusted during initial start-up, as instructed by Somfy Systems, Inc.

RISKS

2.3

DANGER OF FINGERS/ARMS GETTING CAUGHT in the folding arms while the awning is closing and opening.

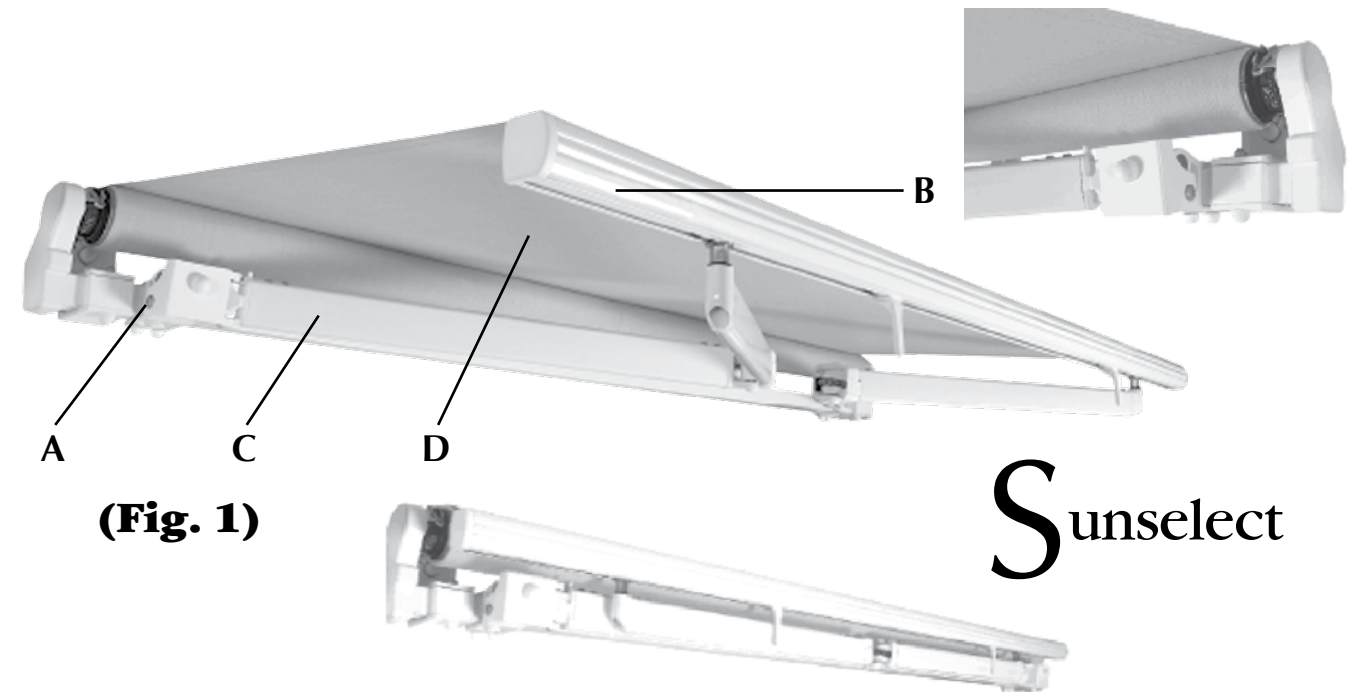

(Fig. 1)

Description of Awning

3.0

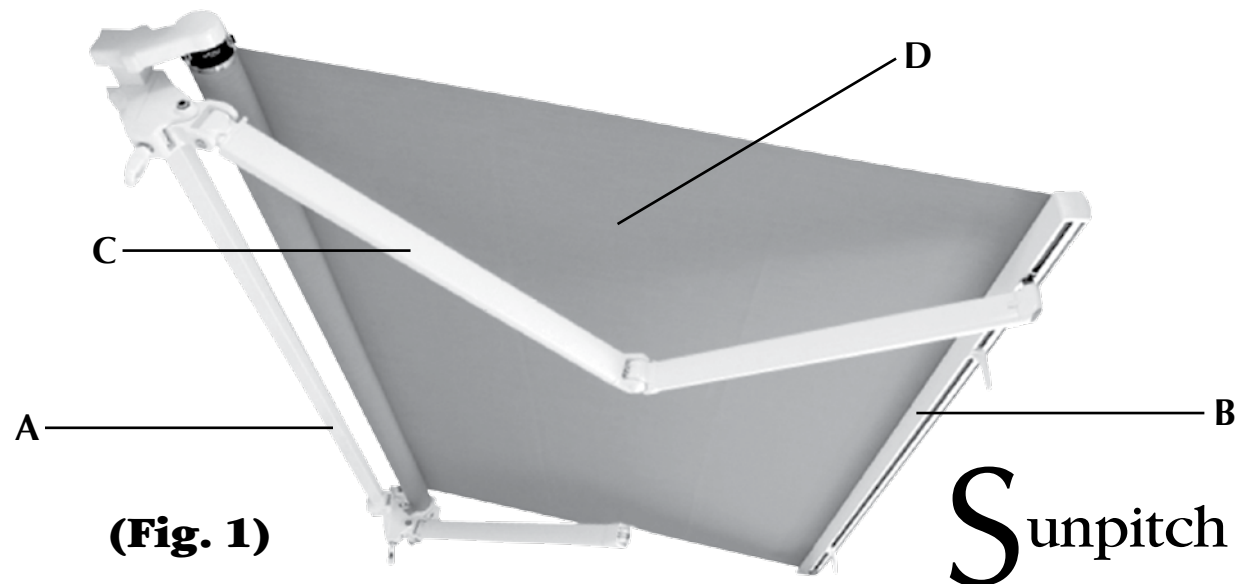

(Fig. 1)

The Sunpitch and Sunselect folding arm awning models can be installed on a wall, soffit or roof and can either be manually operated or powered by a motor. Other accessories can be added on request.

COMPONENTS

3.1

The awning is made up of a metal structure and a piece of fabric.

- Metal structure: consists of a frame containing the working mechanisms for opening and closing the awning. It includes a square bar (**A - Fig. 1**), a front bar (**B - Fig. 1**) and folding arms (**C - Fig. 1**) fitted with sheathed cables.
- Fabric (**D - Fig. 1**) attaches to the frame and provides shade.

The construction materials have been chosen to optimize resistance to wear deriving both from use and the weather. All fabric is subject to variations in surface uniformity. If you notice some color variation in the fabric, please be assured that it is normal. Wrinkling or dimpling are natural occurrences with retractable awnings. The hems and seams create double layers which make the fabric thicker and tighter at the seams. This can cause dimpling anywhere in the fabric. This dimpling will not affect the quality of your fabric or awning. If you notice some light lines or a marbling effect, this is called “crazing” and it will not affect the quality of the fabric. It is also possible for the awning fabric to sag as a result of its own weight. Stretching sometimes occurs with awning fabric. If you notice that your awning is sagging, retract the awning slightly to restore tension.

Conditions of Use

3.2

This awning has been designed to offer protection from the sun and adjust the reflection of light in the area beneath it; the product may only be used to move the incorporated fabric in and out in order to reach its fully open and closed positions and, where applicable, intermediate positions.

The awning may only be used for the above purpose, even if it is installed with a waterproof or PVC fabric. The awning may be used by adult operators.



ATTENTION

IT IS FORBIDDEN to use the awning for any other purpose as the relative operating conditions could jeopardize personal safety.

IT IS FORBIDDEN to place objects on the awning and/or hang onto it.

The Manufacturer declines all liability for injury to persons or damage to property deriving from improper use.

Failure to observe the conditions of use automatically invalidates any warranty granted by the Manufacturer.

 **ATTENTION**
IT IS FORBIDDEN to install powered awning in explosive atmospheres.

 **ATTENTION**
In the event of rain, wind or snow, fully close the awning. Danger of personal injury or damage to property.

 **INFORMATION AND PRECAUTIONS**
Operating the awning in icy weather will damage it!

The product may be installed at any height over 8'2.5" from the ground; the opening/closing switch (only for powered awnings) must be fitted in a protected position in a safe area.

 **ATTENTION**
Fit a keyswitch if the awning is installed in sensitive buildings such as schools, colleges, hospitals, nursing homes, etc.

If the awning is installed with a remote control unit, it must be kept out of reach of children.

The installation area must be large enough to allow the awning to be properly used and opened to its full extent.

 **ATTENTION**
IT IS FORBIDDEN to install or place ladders or other objects in the operating area of the awning.

Excessive heat can cause damage to your awning; therefore, do not barbeque or burn beneath or around your awning.

LABEL **3.3**
Label **(A)**, showing information about the manufacturer, is generally applied to the square bar of the awning.



T ransport & Installation 4.0

Transport **4.1**
Handling and transport operations are performed by the Dealer and/or Manufacturer which undertake to transport the product in suitable packaging and keep it in perfect condition until it is delivered to the customer.
Damage to the product caused by the awning being dismantled and handled/transported after installation is not covered by the warranty.

Installation **4.2**

 **ATTENTION**
Assembly, installation and initial start-up operations may only be performed by suitably qualified specialized technical staff provided by the Dealer or the Manufacturer.

The position chosen by the user to install the product must be able to support the weight of the product and be large enough to allow the awning to open to its full extent.

U se 5.0

 **ATTENTION**
Before using the awning, carefully read Chap. 2 "Safety" and Chap. 3.2 "Foreseen use & Conditions of use".

 **ATTENTION**
Make sure no-one is standing near the awning while it is opening/closing.

 **ATTENTION**
In the event of rain, wind or snow, fully close the awning. Danger of personal injury or damage to property.

- Only use the awning as sun protection and for the purposes indicated in Chapter 3.2 "Condition of Use" of this manual.
- It is strictly forbidden to climb onto or hang/place objects on the awning.
- If mold develops on the fabric, clean it as shown in Chapter 6.2 "Cleaning".
In the event of a malfunction, contact your local Perfecta dealer.

Manual Awning Operation

5.1

Open and close the awning using the supplied rod (A - Fig. 1) and crank (B - Fig. 1).

To extend:

- Insert the hook of the hand crank into the gear eye located on the end of the unit.
- Turn the handle to extend the unit. Be careful not to roll the fabric out past the point where the elbows lock out and the fabric begins to sag. If this occurs, turn the crank handle in the opposite direction until the fabric becomes tight again. The arms should always have a slight bend to them, which allows the unit to react in various weather conditions.

To retract:

- Insert the hook of the hand crank and turn the crank handle in the direction to retract the fabric.
- Continue turning the crank until the front bar sits tightly against the roller tube and the fabric is protected under the hood or awning shell.
- Fabric should **ALWAYS** roll off the top of the roller tube. Failure to do so could cause danger or damage to awning (Fig. 2).

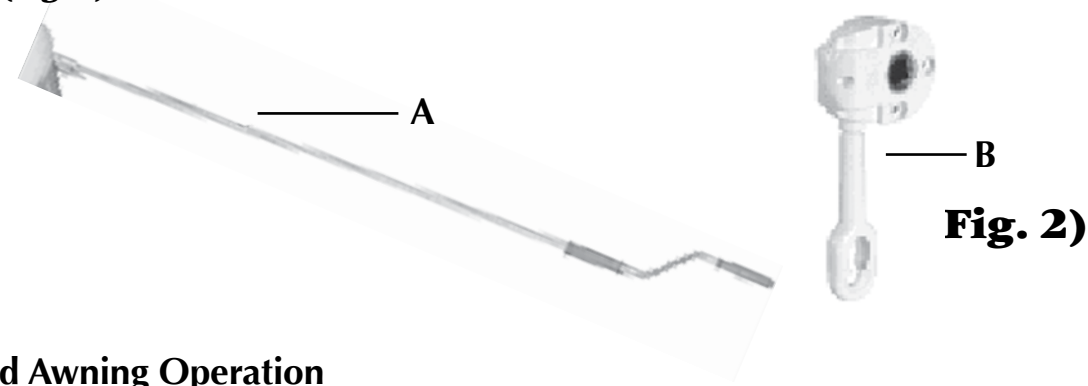

Powered Awning Operation

5.2



ATTENTION

Assembly, installation and initial start-up operations may only be performed by suitably qualified specialized technical staff provided by the Dealer or the Manufacturer.

Generally, motors are supplied by Somfy Systems, Inc., the acknowledged world leader in specialized motors. Motors are placed in the roller tube and require little or no maintenance. If a motor should fail to function, contact your local Perfecta dealer for service.

Override motors allow you the safety and convenience of manual operation during an electrical failure. Somfy motors also have an automatic overheat protection thermal switch. Repetitive use of your retractable awning may cause the motor to overheat. This thermal switch will stop the motor from working for 15-20 minutes to cool itself, rather than be damaged by excessive heat. For more detailed motor information, visit the manufacturer's website at www.somfysystems.com.

Open and close the awning using the portable **REMOTE CONTROL (Fig. 1)**

To extend:

- Press and release the √ button to extend the awning to the preset limit.

To retract:

- Press and release the ^ button to retract the awning to the preset limit.

To stop movement:

- Press and release the middle button.



(Fig. 1)

Please see www.somfysystems.com for more information on Motor, Automatic Devices and Controls.

Automatic Operation

5.3

3D Eolis Wirefree RTS Motion Sensor

Motion sensors are usually mounted on the arm of the awning. Upon detection of vibration, the sensor emits a signal to retract the awning automatically. When the battery is low, the sensor will send a close command and shut down.



Sunis (Sun & Motion) Wirefree RTS Motion Sensor

Upon detection of sunlight, the sensor emits a signal to extend the awning based on the sun's intensity. When the battery is low, the sensor will send a close command and shut down.



ATTENTION

It is strongly recommended to disable the sun control when your awning will be unused for an extended period of time. Do not rely on optional motion sensors or sun/motion control to protect against wind damage. Wind damage is not covered under warranty.

To control your awning, simply press and hold the button on the bottom of the remote to identify the current mode. Continue to hold the button to select a different mode. Once the mode has changed, release the button. The left side indicates motion control function. The right side of the remote indicates both the sun and motion control function.



Maintenance

6.0



ATTENTION

Switch off the main supply before carrying out any maintenance and cleaning operations. Before operating the awning, carefully read Chap. 2 "Safety". Installation, initial start-up, adjustments and extraordinary maintenance operations may only be performed by suitable qualified specialized technical staff. Please contact Technical Assistance.

Routine Maintenance

6.1



ATTENTION

Switch off the main supply before carrying out any maintenance and cleaning operations.

If performed at the indicated frequencies, the following operations will keep the product in good condition.

Twice a year, before and after summer:

Check the fabric for tears or broken stitching: in spring, before use in summer, and in autumn, before closing for winter.

Once a year, before summer:

With the awning approximately half open, lubricate all moving parts with silicon oil:

- Lubricate the awning on the part opposite the control (motor or crank-rod) (C - Fig. 2).

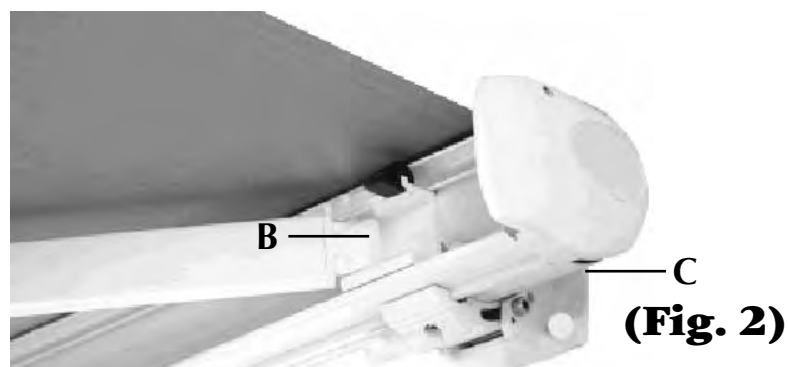

(Fig. 2)

Check all fasteners (nuts, bolts, lags, etc.) for tightness.
 Test the operation of the awning to be sure the extension and closure of the awning is working properly.
 Be sure the awning closes tightly against the roller tube in order to keep your fabric clean.

Reinstall the valance by doing the following:

Simply remove the one small screw from the bottom of the end cap.
 Insert the PVC into the valance hem. **(A - Fig. 3)**
 Next, one person should guide the valance into the track going in the direction of the seams being careful not to tear the stitching or fabric.
 The other person should guide the valance as it is pulled.
 Line the fabric valance up with the main body fabric.
 Re-attach the end cap to its original position and tighten the screw.

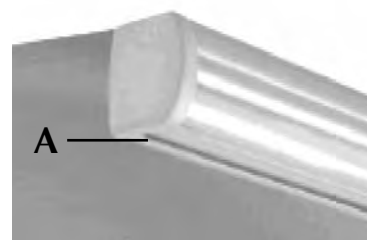

(Fig. 3)

(Fig. 3)

Once a year, before winter

Before retracting your awning for the last time, make sure the awning fabric is clean and dry to prevent mildew from forming over the winter.

We also recommend the removal of the valance to prevent weathering.

Remove the one small screw from the end cap.
 Slide the valance out to the left when facing the awning, out of the front bar removing both the valance and the PVC tubing.
 Pull the PVC tubing out of the valance hem.
 Roll up the valance.
 Replace the PVC tubing back in the front bar.
 Re-attach the end cap to its original position and tighten the screw.

**If you have a vario-volant drop, remove the bottom pipe out of the pocket on the bottom.

Roll valance up into the cassette and store the pipe in a safe place.
 Be sure to place the valance in a dry, well-ventilated area away from rodents for the winter season.
 Never store your fabric in a plastic bag; this can trap moisture and promote mildew.

If you have a plug-in motor, we suggest unplugging the power cord from your wall outlet and covering the socket to prevent rain and moisture from entering the outlet.



ATTENTION

Switch off the main supply before carrying out any maintenance and cleaning operations.

Keep the fabric clean to prevent the formation of mold caused by deposits of dust or other materials on the fabric; this can be done by vacuuming the dust or cleaning the fabric with a sponge or cloth and warm water. Dry the fabric afterwards. Never allow debris to be rolled up in your awning. These items can cause staining or puncturing. Never allow birds to nest on or near your awning.

If installation is near saltwater, rinse the awning framework at least once a month with water and lubricate the moving parts with silicone spray. Avoid spraying the silicone on the fabric since this may cause discoloration or staining. For added protection, you may apply a nonabrasive wax to the frame.

Cleaning using ladders, scaffolding and the like may only be performed by special staff who must observe current safety legislation and use personal protective equipment such as safety harnesses and cables.



ATTENTION

Do not use solvents - ammonia - hydrocarbons.



ATTENTION

In case of faults or when troubleshooting, observe the safety regulations; in particular, danger of lethal electrocution when troubleshooting or repairing electrical faults.
ELECTRICAL MAINTENANCE MAY ONLY BE PERFORMED BY QUALIFIED STAFF.

For any problems that are not indicated in the following table, please contact your local Perfecta dealer.

MANUAL AWNING

PROBLEM

The fabric does not roll up straight

REASON

Arms out of symmetry
 Fabric thickness not uniform

REMEDY

Contact Local Dealer
 Fully rewind the fabric

POWERED AWNING

Without electronic power unit

PROBLEM

The fabric does not roll up straight

REASON

Arms out of symmetry
 Fabric thickness not uniform

REMEDY

Contact Local Dealer
 Fully rewind the fabric

The awning does not fully close
 The awning does not fully open
 The motor is very noisy

Limits incorrectly adjusted
 Motor gear moves
 Faulty wiring
 Faulty motor

Contact Local Dealer
 Contact Local Dealer
 Contact Local Dealer
 Contact Local Dealer

The motor stops after 4-5 minutes of continuous use

Motor overheating
 Protection tripped

Let the motor cool down for 20 minutes

POWERED AWNING

With electronic power unit

PROBLEM

The awning does not move

The awning moves jerkily

The awning does not close in strong winds with motion sensor.

With the remote control unit, the awning opens or closes by itself.

REASON

Fuse blown
Faulty wiring

Wind sensor faulty

Fuse blown

Wind sensor faulty

Dead battery

REMEDY

Contact Local Dealer
Contact Local Dealer

Contact Local Dealer

Contact Local Dealer

Contact Local Dealer

Replace the batteries in the remote control unit (see Control instructions)

Extraordinary Maintenance

6.4



ATTENTION

All extraordinary maintenance operations must only be performed by professional qualified and trained staff. Contact Technical Assistance for a specialist.
To dismantle all or part of the awning, consult the assembly, installation and start-up instructions. The warranty will cease to be valid if unoriginal spare parts are used.

Spare parts must be requested from an authorized Perfecta dealer.

D

ismounting & Disposal

7.0



ATTENTION

The awning must be dismantled by professionally qualified and trained staff.
Contact Technical Assistance for a specialist.

Close the awning before starting.

Turn off the main power supply and disconnect the circuit from the switch.

Disconnect the motor, tie the arms together, dismantle the supports and remove the awning from the supports.

As the awning contains no hazardous materials, no special disposal precautions are required.

Observe the regulations in force at the time of disposal.



Retractable Fabric Awnings

"Our Name Reflects Our Quality"

www.perfectaawnings.com